

Найди лишнюю картинку в каждом ряду.  
(наличие/отсутствие звука [с] в слове)

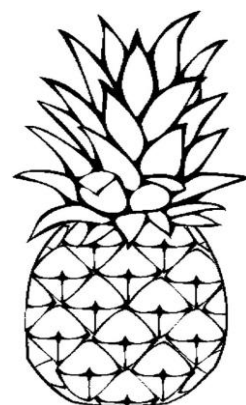

Найди лишнюю картинку в каждом ряду.  
(дифференциация с-с')

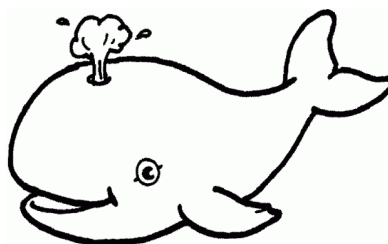
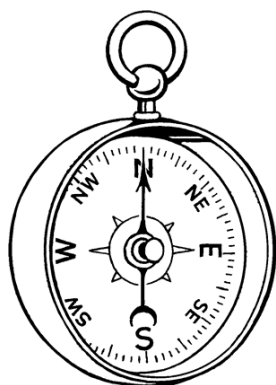
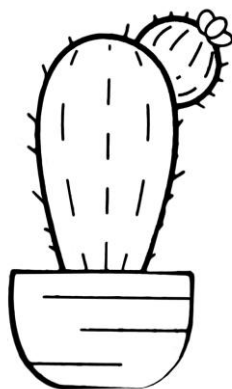
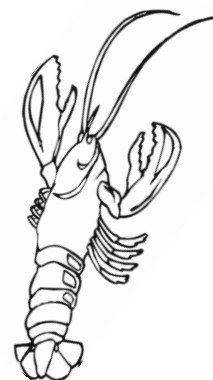
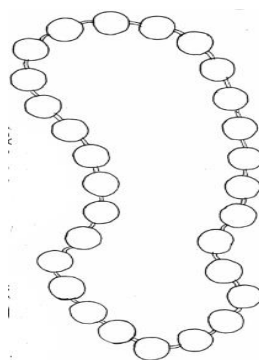
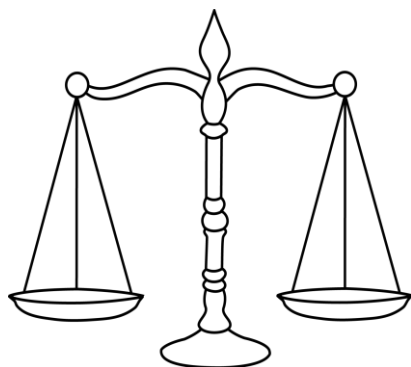
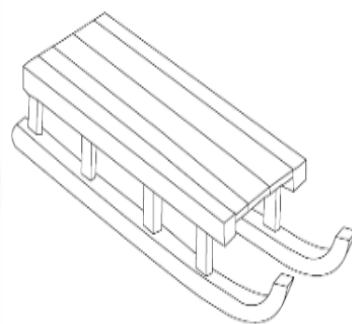
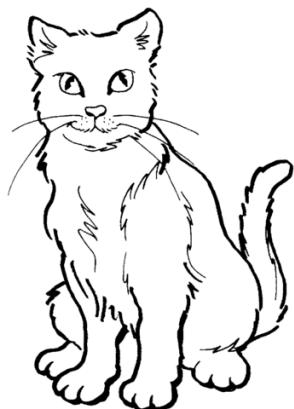
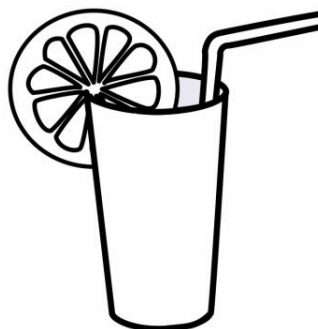
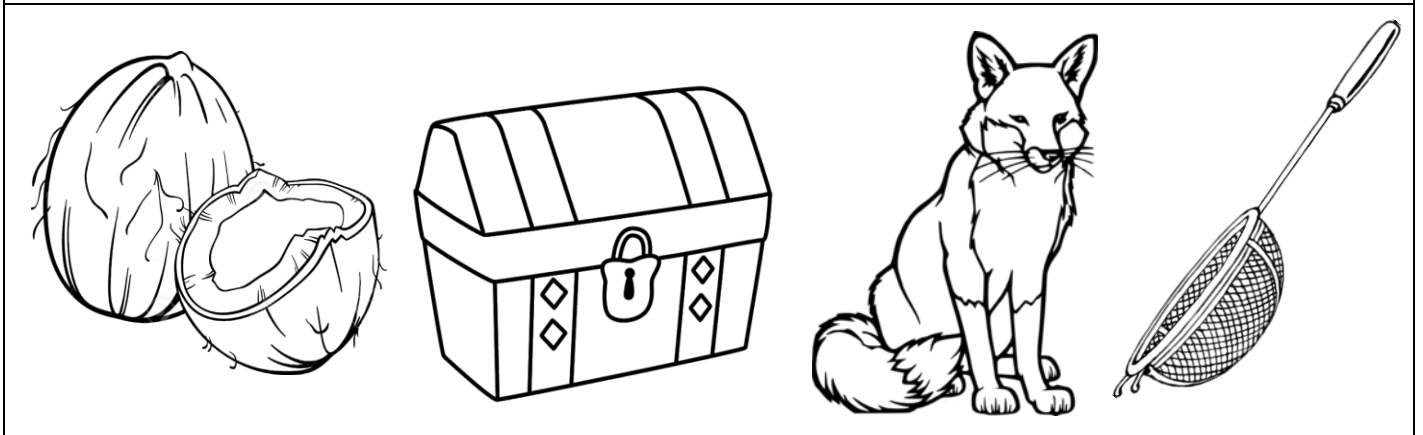
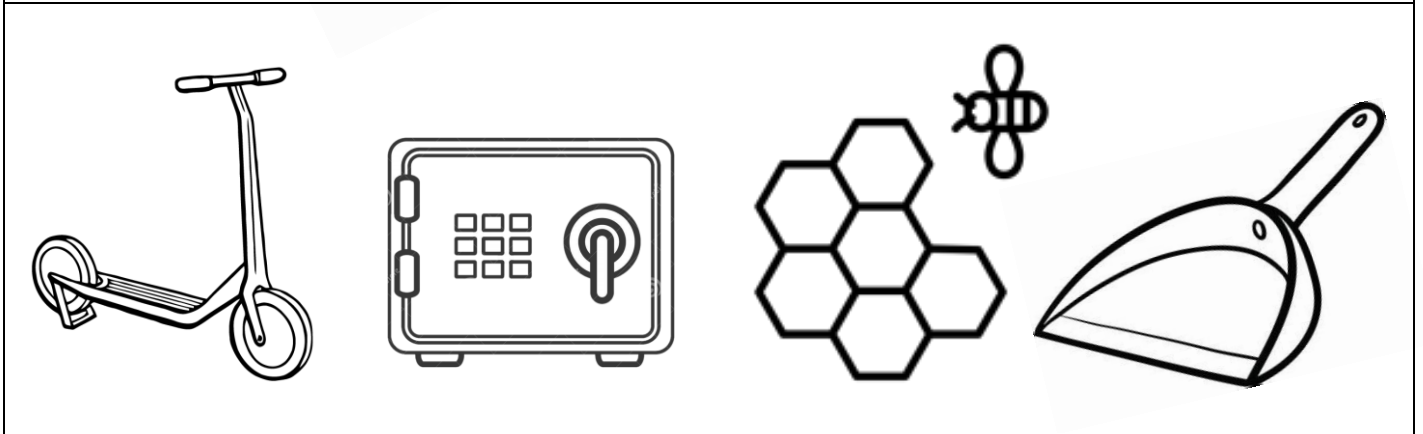
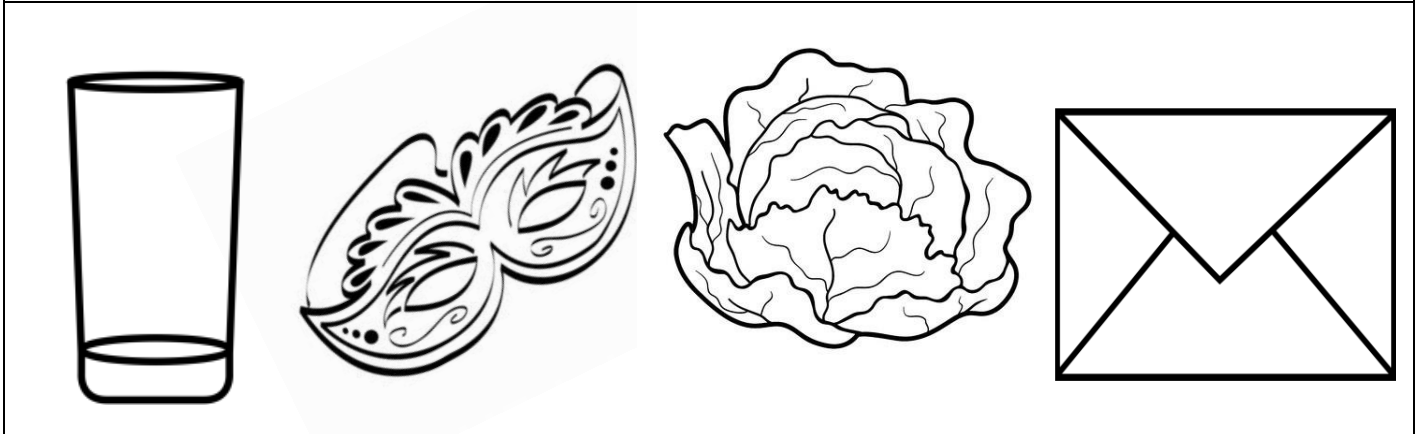
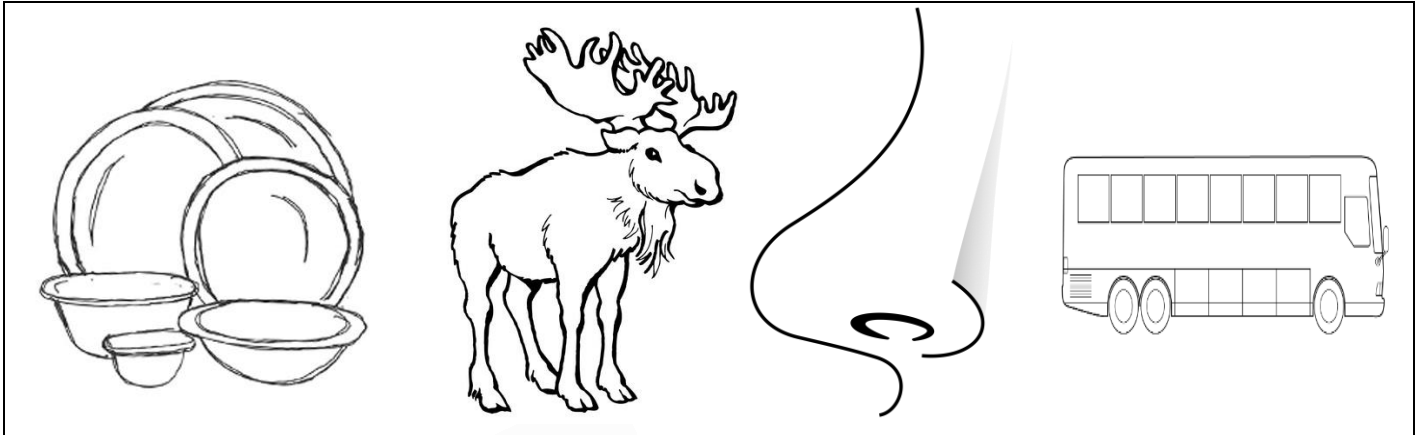

Найди лишнюю картинку в каждом ряду.  
(дифференциация с-з)

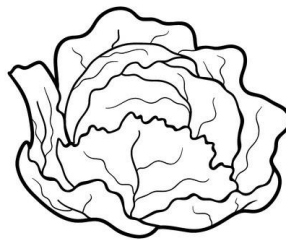
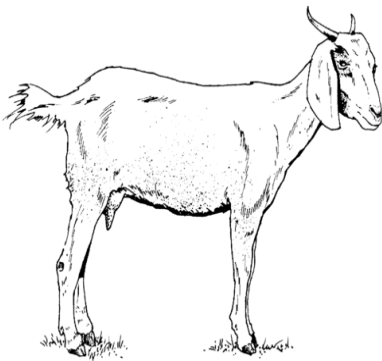
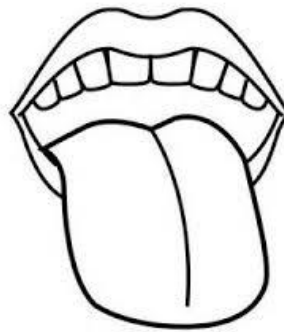
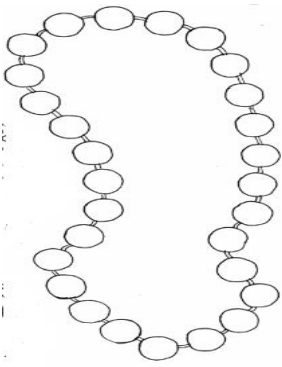
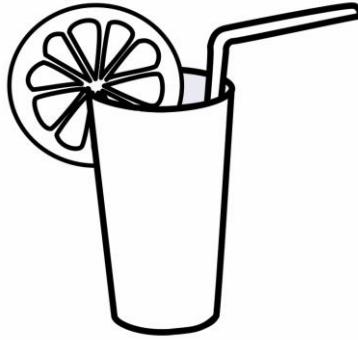
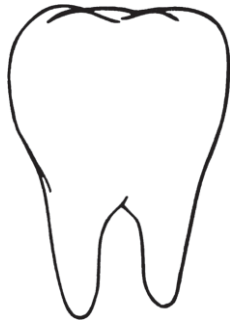

Найди лишнюю картинку в каждом ряду.  
(дифференциация с-ш)

